



**Ningbo Haitian Precision Machinery Co., Ltd.**

**H.Q. & Production Base1**

No. 1688 Haitian road, Xiaogang, Beilun, Ningbo-315801, China.  
Tel: +86-574-86182580/86182525  
E-mail: hision@mail.haitian.com

**Production Base2**

No.235, Huangshan Road, Beilun District, Ningbo-315801 China.

**Production Base3**

No.188, Baodao Road, Lin'gang Industrial Zone, Changxing Island,  
Dalian-116317 China.

**Haitian Precision Machinery (HONGKONG) Co., Ltd.**

**Office Address:**

Unit, 12/F, Seabright Plaza, 9-23 Shell Street, North Point, HONGKONG.

**Website:**

**[www.haitianprecision.com](http://www.haitianprecision.com)**



NEW 2020-EN-L-B The text description, pictures and technical parameters in the sample are for reference only, and the changes due to technological development are subject to change without notice.

**VERTICAL MACHINING CENTER  
DOUBLE COLUMN MACHINING CENTER**

V180 / VMC II / GU II / GUE  
GLU II / GLU (e) / GRU II / GNU

**HISION**



V180



VMC II Series



GU II Series



## Vertical Machining Center

VMC II series vertical machining center was designed and developed independently by absorbing and digesting advanced technologies domestic and abroad on the basis of the existing machine of Haitian Precision company. It can be used in the fields of automobile parts, plastic machinery, construction machinery, etc.

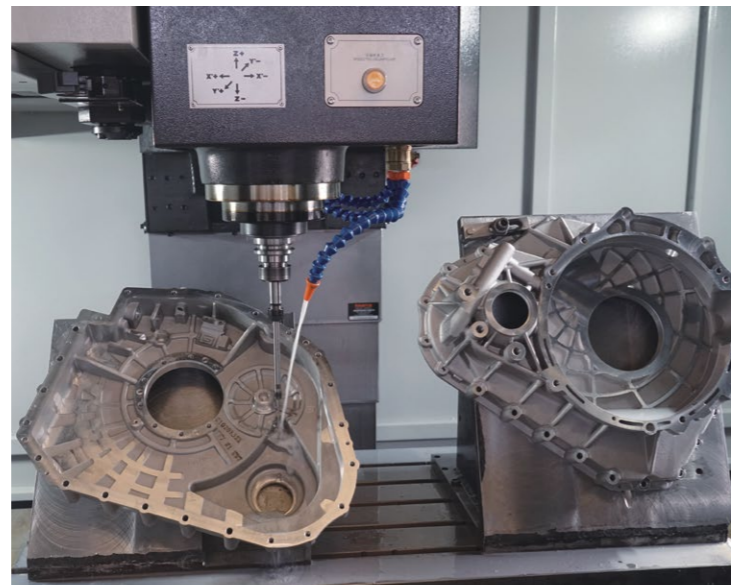

## Double Column Machining Center

On the basis of inheriting the double column structure and market demand, the product has newly introduced with boxway ram structure, which further expands the advantages of the double column vertical machining center and the traditional machining center, bringing a new experience to customers.

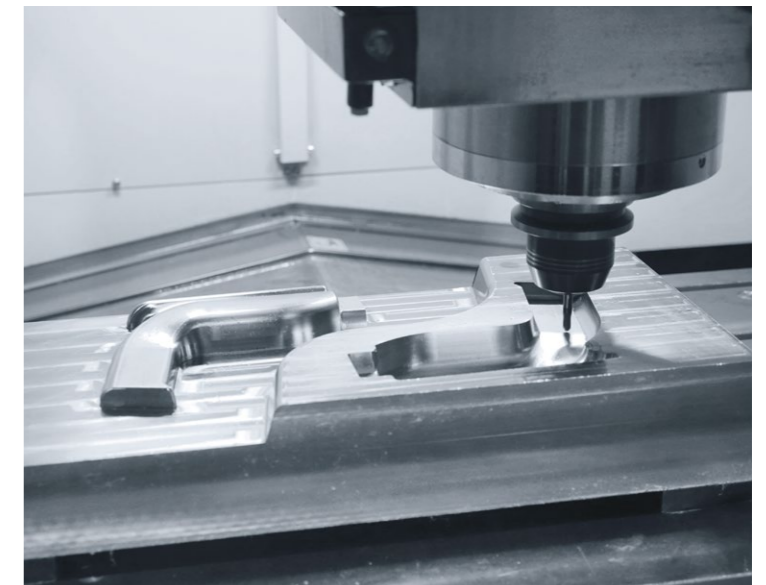

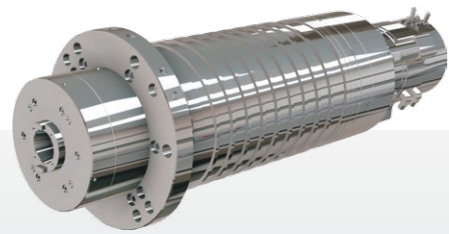

Hision Built-in Spindle



GLU II / GLU (e)13/16 Series



GLU / GLU (e)18/23/28 Series ( Full enclosure option )



GRU II 28/32/36 Series GNU 28/32/36 Series



## Fixed Crossrail Double Column Machining Center

Inheriting the structural characteristics of strong rigidity and wide processing range of traditional gantry products, integrating advanced technical elements, and pursuing the development concept of high efficiency, high precision, and energy saving. Create new generation of U series gantry machining center. Widely used in mold, aerospace, rail transportation, automotive, house appliances, medical and other high-end manufacturing industries.

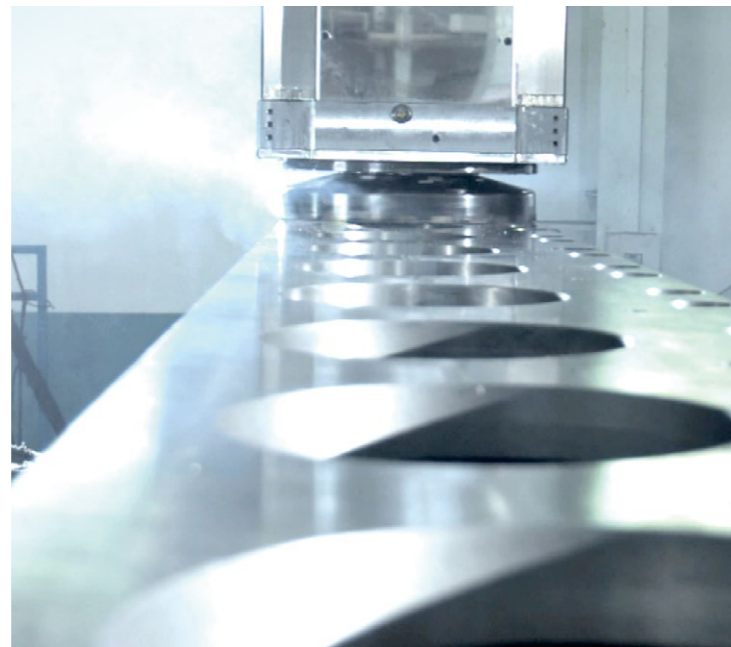

### • GLU II Series

GLU II series adopt full gear transmission and special Z-axis boxway layout technology (Haitian precision company patented technology) to achieve the perfect integration of strength and high-precision processing.

### • GLUe Series

GLUe series adopt the struture of built-in spindle with the heavy cutting ability , which brings customers the processing experience of high torque, high speed and low vibration.

### • GLU Series

GLU series adopt full gear transmission ram, two speed shift gear box to achieve high speed, high torque cutting.

### • GRU II / GNU Series

GRU II /GNU series adopts square ram, which has high rigidity structure, strong and stable cutting performance.



## Attachment For Various Application



90° auto milling head

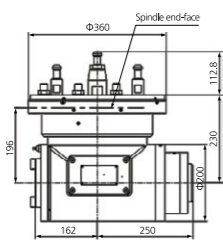

Max Power: 15kW  
Max Speed: 2000rpm



90° manual milling head

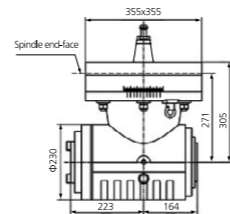

Max Power: 20kW/15kW (OPT)  
Max Speed: 2000rpm



Semi auto 3+2 milling head

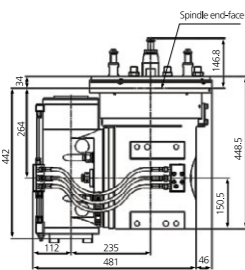

Max Power: 15kW  
Max Speed: 2000rpm



Auto 3+2 milling head

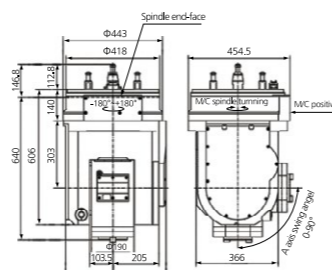

Max Power: 15kW  
Max Speed: 4000rpm



Automatic extended milling head

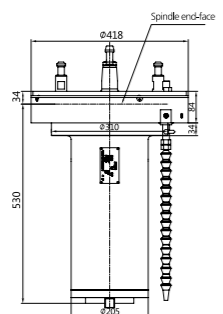

Max Power: 20kW  
Max Speed: 2000rpm



Automatic universal Milling head

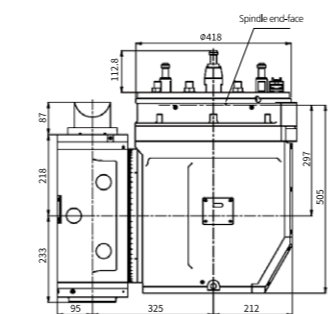

Max Power: 15kW  
Max Speed: 4000rpm

## Automatic Attachment Charger



Two stations auto head storing shelf



Attachment head holder

# V180 / VMC II

Items	Unit	V180	VMC760 II	VMC850 II	VMC1000 II	VMC1200 II
<b>» Machining Capacity</b>						
X travel	mm	500	760	850	1000	1200
Y travel	mm	400	400	500	600	600
Z travel	mm	330	500	500	600	600
Spindle nose to table surface	mm	150-480	150-650	150-650	150-750	150-750
<b>» Table</b>						
Table size	mm	650x400	900x400	1000x500	1200x600	1300x600
Table load	t	0.255	0.3	0.6	0.8	0.6
T slot	mm	14x125x3	18x125x3	18x80x5	18x100x5	18x100x5
<b>» Feed Rate</b>						
Rapid traverse (X/Y/Z)	m/min	48/48/48	36/36/36	36/36/36	36/36/36	36/36/36
Cutting feedrate (X/Y/Z)	m/min	30/30/30	15/15/15	15/15/15	15/15/15	15/15/15
<b>» Spindle</b>						
Max Spindle speed	rpm	20000	8000	8000	8000	8000
Spindle power	kW	3.7/5.5	5.5/7.5	7.5/11	7.5/11	7.5/11
Spindle torque	N.m	11.7/17.5	52.5/71.6	71.6/105	71.6/105	71.6/105
Spindle taper		BT30	BT40	BT40	BT40	BT40
Pull stud		MAS-P30T-1	P40T - I - MAS403	P40T - I - MAS403	P40T - I - MAS403	P40T - I - MAS403
<b>» Tool Magazine</b>						
Tool magazine capacity	T	16	24	24	24	24
Tool magazine type		-	Arm type	Arm type	Arm type	Arm type
Max.tool dia. (Adjacent vacant)	mm	Φ60 (Φ80)	Φ78(Φ150)	Φ78(Φ150)	Φ78(Φ150)	Φ78(Φ150)
Max.tool length	mm	250	300	300	300	300
Max.tool weight	kg	3	7	7	7	7
Tool change time	s	1.6	2.5	2.5	2.5	2.5
<b>» Other</b>						
Power capacity	kVA	15	25	25	25	30
Machine weight	t	2.5	5.5	6	6.5	7
Machine size(L×W×H)	cm	162x208x238	230x325x255	250x340x255	280x355x265	315x355x270

### V180 Standard Configuration

1. Controller:M80B
2. Spindle air blow
3. Spindle air seal
4. Spindle oil chiller
5. Hydraulic and lubrication system
6. Coolant system
7. Rigid tapping
8. Direct drive spindle 20000rpm
9. 16T disc type ATC
10. 3-color signal lamp,working light

### VMC II Standard Configuration

1. Controller: Mitsubishi M80B
2. 8000rpm mechanical spindle
3. ATC
4. Pneumatic,hydraulic and lubrication system
5. Cutting cooling
6. Internal helix chip conveyor
7. Full enclosure with top cover
8. Air gun
9. 3-color signal lamp, working light
10. Standard accessories

### V180 Option Configuration

1. Controller: M80A
2. CNC rotary talbe (4th axis)
3. Pre-researve CNC rotary table interface
4. Tool setter-TS27R
5. Full enclosure with top cover
6. Oil mist collector
7. Workpiece air blow
8. Workpiece probe
9. Air gun
10. Water gun

### VMC II Option Configuration

1. Controller: FANUC Oi
2. Controller: MITSUBISHI M80A
3. Air conditioner
4. Spindle oil chiller
5. Auto door
6. ATC protection door
7. CNC rotary table (4th)
8. Workpiece probe(2D)
9. Tool setter
10. Water gun
11. Coolant through spindle (2-6MPa)
12. Spindle ring spray
13. Oil skimmer
14. Oil mist collector
15. External chain type chip conveyor and trolley
16. External scrap type chip conveyor and trolley
17. Directly drive spindle 10000rpm/12000rpm



# GU II / GUE

Items	Unit	GU5 II	GU6 II	GUE5	GUE6
» Machining Capacity					
X travel	mm	1500	1500	1500	1500
Y travel	mm	700	850	700	850
Z travel	mm	600	700	600	700
Distance between columns	mm	1580	1580	1580	1580
Spindle nose to table surface	mm	205-805	205-905	150-750	150-850
» Table					
Table size	mm	1400×700	1500×850	1400×700	1500×850
Table load	t	2	3	2	3
T slot	mm	18×150×5	18×160×5	18×150×5	18×160×5
» Feed Rate					
Cutting feedrate (X/Y/Z)	m/min	12/12/10	12/12/10	20/20/10	20/20/10
Rapid traverse (X/Y/Z)	m/min	20/20/15	20/20/15	24/24/15	24/24/15
» Spindle					
Drive type		Gear box	Gear box	Built-in spindle	Built-in spindle
Max Spindle speed	rpm	6000	6000	6000	6000
Spindle power	kW	15/18.5	15/18.5	15/30 (low speed) 22/30 (high speed)	15/30 (low speed) 22/30 (high speed)
Spindle torque	N.m	316/522	316/522	318/774 (low speed) 233/318 (high speed)	318/774 (low speed) 233/318 (high speed)
Spindle taper		BT50	BT50	BT50	BT50
Pull stud		P50T- II -MAS403 (BT50-60°)	P50T- II -MAS403 (BT50-60°)	P50T- II -MAS403 (BT50-60°)	P50T- II -MAS403 (BT50-60°)
» Tool Magazine (Option)					
Tool magazine capacity	T	24	24	24	24
Tool magazine type		Arm type	Arm type	Arm type	Arm type
Max.tool dia. (Adjacent vacant)	mm	Φ110 (Φ200)	Φ110 (Φ200)	Φ110 (Φ200)	Φ110 (Φ200)
Max.tool length	mm	300	300	300	300
Max.tool weight	kg	20	20	20	20
» Other					
Power capacity	kVA	40	40	65	65
Machine weight	t	13	13.7	13	13.7
Machine size(L×W×H)	cm	440×335×410	440×335×420	440×335×410	440×335×420

## Standard Configuration

1. Controller:MITSUBISHI M80B (only for GUE)
2. Controller:FANUC Oi(only for GUII)
3. Spindle oil chiller
4. Pneumatic,hydraulic and lubrication system
5. Cutting cooling
6. Internal helix chip conveyor
7. External chain type chip conveyor and trolley
8. Full enclosure
9. 3-color signal lamp, working light
10. Standard accessories
11. 6000rpm HISION built-in spindle (only for GUE)

## Option Configuration

1. 24T ATC
2. CNC rotary table(4th)
3. Coolant through spindle (2-6MPa)
4. Linear scale
5. Workpiece probe(2D)
6. Tool setter
7. Oil skimmer
8. Air conditioner
9. Full enclosure with top cover
10. Water gun
11. Oil mist collector
12. Manual 90° milling head(4x90°)
13. Air gun
14. Controller:MITSUBISHI M80A (only for Gue)
15. Controller:FANUC Oi for 8000rpm built-in spindle(only for Gue)
16. 8000rpm HISION built-in spindle (only for GUE)
17. Spindle ring spray(only for Gue)

# GLU II

Items	Unit	GLU13 II ×16	GLU13 II ×21	GLU13 II ×30	GLU16 II ×20	GLU16 II ×25
» Machining Capacity						
X travel	mm	1600	2000	3100	2000	2500
Y travel	mm	1300	1300	1300	1500	1500
Z travel	mm	700	700	700	700	700
Distance between columns	mm	1380	1380	1380	1580	1580
Spindle nose to table surface	mm	205-905	205-905	205-905	255-955	255-955
» Table						
Table size	mm	1300×1800	1300×2200	1300×3000	1500×2000	1500×2500
Table load	t	4	5	7	6	8
T slot	mm	22×160×8	22×160×8	22×160×8	22×160×9	22×160×9
» Feed Rate						
Cutting feedrate (X/Y/Z)	m/min	12/12/10	12/12/10	12/12/10	12/12/10	12/12/10
Rapid traverse (X/Y/Z)	m/min	15/20/15	12/20/15	12/20/15	12/20/15	12/20/15
» Spindle						
Drive type		Gear box	Gear box	Gear box	Gear box	Gear box
Max Spindle speed	rpm	6000	6000	6000	6000	6000
Spindle power	kW	15/18.5	15/18.5	15/18.5	15/18.5	15/18.5
Spindle torque	N.m	316/522	316/522	316/522	316/522	316/522
Spindle taper		BT50	BT50	BT50	BT50	BT50
Ram section	mm	350×350	350×350	350×350	350×350	350×350
» Tool Magazine (Option)						
Tool magazine capacity	T	24	24	24	24	24
Tool magazine type		BT50	BT50	BT50	BT50	BT50
Max.tool dia. (Adjacent vacant)	mm	Φ110 (Φ220)	Φ110 (Φ220)	Φ110 (Φ220)	Φ110 (Φ220)	Φ110 (Φ220)
Max.tool length	mm	300	300	300	300	300
Max.tool weight	kg	20	20	20	20	20
» Other						
Power capacity	kVA	40	40	40	40	40
Machine weight	t	16	19	24	20	23
Machine size(L×W×H)	cm	560×388×420	690×388×420	880×388×420	741×400×432	777×400×432

## Standard Configuration

1. Controller: FANUC Oi
2. Gear box drive
3. Spindle oil chiller
4. Z axis hydraulic balancing system Pneumatic,hydraulic and
5. lubrication system
6. Cutting cooling
7. Internal helix chip conveyor
8. External chain type chip conveyor
9. Full enclosure
10. 3-color signal lamp, working light
11. Standard accessories
12. Common maintenance tools

## Option Configuration

1. 24/32T ATC
2. Column heighten 200mm
3. Coolant through spindle (2-6MPa)
4. Linear scale
5. CNC rotary table(4th)
6. Full enclosure with top cover
7. Air conditioner
8. Manual 90° milling head(4x90°)
9. Workpiece probe(2D)
10. Tool setter
11. Oil skimmer
12. Water gun
13. Oil mist collector
14. Air gun



# GLUe

Items	Unit	GLUe13×16	GLUe13×21	GLUe13×30	GLUe16×20	GLUe16×25	GLUe16×30
<b>» Machining Capacity</b>							
X travel	mm	1600	2000	3100	2000	2500	3100
Y travel	mm	1300	1300	1300	1500	1500	1500
Z travel	mm	700	700	700	700	700	700
Distance between columns	mm	1380	1380	1380	1580	1580	1580
Spindle nose to table surface	mm	150-850	150-850	150-850	200-900	200-900	200-900
<b>» Table</b>							
Table size	mm	1300×1800	1300×2200	1300×3000	1500×2000	1500×2500	1500×3000
Table load	t	4	5	7	6	8	10
T slot	mm	22×160×8	22×160×8	22×160×8	22×160×9	22×160×9	22×160×9
<b>» Feed Rate</b>							
Cutting feedrate (X/Y/Z)	m/min	12/20/10	12/20/10	12/20/10	12/20/10	12/20/10	12/20/10
Rapid traverse (X/Y/Z)	m/min	20/24/15	16/24/15	16/24/15	16/24/15	16/24/15	16/24/15
<b>» Spindle</b>							
Drive type		Built-in spindle	Built-in spindle	Built-in spindle	Built-in spindle	Built-in spindle	Built-in spindle
Max Spindle speed	rpm	6000	6000	6000	6000	6000	6000
Spindle power	low speed	kW	15/30	15/30	15/30	15/30	15/30
	High speed	kW	22/30	22/30	22/30	22/30	22/30
Spindle torque	low speed	N.m	318/774	318/774	318/774	318/774	318/774
	High speed	N.m	233/318	233/318	233/318	233/318	233/318
Spindle taper		BT50	BT50	BT50	BT50	BT50	BT50
Ram section	mm	350×350	350×350	350×350	350×350	350×350	350×350
<b>» Tool Magazine (Option)</b>							
Tool magazine capacity	T	24	24	24	24	24	24
Tool magazine type		BT50	BT50	BT50	BT50	BT50	BT50
Max.tool dia. (Adjacent vacant)	mm	Φ110 (Φ220)	Φ110 (Φ220)	Φ110 (Φ220)	Φ110 (Φ220)	Φ110 (Φ220)	Φ110 (Φ220)
Max.tool length	mm	300	300	300	300	300	300
Max.tool weight	kg	20	20	20	20	20	20
<b>» Other</b>							
Power capacity	kVA	65	65	65	65	65	65
Machine weight	t	16	19	24	20	23	26.5
Machine size(L×W×H)	cm	560×388×420	690×388×420	880×388×420	741×400×432	777×400×432	941×400×432

## Standard Configuration

1. Controller:MITSUBISHI M80A
2. HISION built-in spindle
3. Spindle oil chiller
4. Pneumatic,hydraulic and lubrication system
5. Simple splash guard
6. Internal helix chip conveyor
7. External chain type chip conveyor
8. Cutting cooling
9. 3-color signal lamp, working light
10. Standard accessories
11. Common maintenance tools

## Option Configuration

1. Controller:FANUC 0i
2. 24/32T ATC
3. Column heighten 200mm
4. Coolant through spindle (2-6MPa)
5. Spindle ring spray
6. Linear scale
7. CNC rotary table(4th)
8. Full enclosure with top cover
9. Air conditioner
10. Manual 90° milling head
11. Workpiece probe(2D)
12. Tool setter
13. Oil skimmer
14. Water gun
15. Oil mist collector
16. Air gun
17. 8000rpm HISION built-in spindle

# GLUe

Items	Unit	GLUe18×30	GLUe23×30	GLUe23×40	GLUe28×30	GLUe28×40	GLUe28×50	GLUe28×60
<b>» Machining Capacity</b>								
X travel	mm	3200	3200	4200	3200	4200	5500	6500
Y travel	mm	1700	2200	2200	2700	2700	2700	2700
Z travel	mm	800	800	800	800	800	800	800
Distance between columns	mm	1800	2290	2290	2790	2790	2790	2790
Spindle nose to table surface	mm	250-1050	250-1050	250-1050	250-1050	250-1050	250-1050	250-1050
<b>» Table</b>								
Table size	mm	1500×3000	2000×3000	2000×4000	2000×3000	2000×4000	2000×5000	2000×6000
Table load	t	10	15	18	15	18	22	25
T slot	mm	22×160×9	22×200×9	22×200×9	22×200×9	22×200×9	22×200×9	22×200×9
<b>» Feed Rate</b>								
Cutting feedrate (X/Y/Z)	m/min	10/10/10	10/10/10	10/10/10	10/10/10	10/10/10	10/10/10	10/10/10
Rapid traverse (X/Y/Z)	m/min	15/20/15	15/20/15	12/20/15	15/15/15	12/15/15	10/15/15	10/15/15
<b>» Spindle</b>								
Drive type		Built-in spindle	Built-in spindle	Built-in spindle	Built-in spindle	Built-in spindle	Built-in spindle	Built-in spindle
Max Spindle speed	rpm	8000	8000	8000	8000	8000	8000	8000
Spindle power	kW	26/45	26/45	26/45	26/45	26/45	26/45	26/45
Spindle torque	N.m	305/623	305/623	305/623	305/623	305/623	305/623	305/623
Spindle taper		BT50	BT50	BT50	BT50	BT50	BT50	BT50
Ram section	mm	380×380	380×380	380×380	380×380	380×380	380×380	380×380
<b>» Tool Magazine (Option)</b>								
Tool magazine capacity	T	24	24	24	24	24	24	24
Tool magazine type		BT50	BT50	BT50	BT50	BT50	BT50	BT50
Max.tool dia. (Adjacent vacant)	mm	Φ110 (Φ220)	Φ110 (Φ220)	Φ110 (Φ220)	Φ110 (Φ220)	Φ110 (Φ220)	Φ110 (Φ220)	Φ110 (Φ220)
Max.tool length	mm	300	300	300	300	300	300	300
Max.tool weight	kg	20	20	20	20	20	20	20
<b>» Other</b>								
Power capacity	kVA	60	60	60	60	60	60	60
Machine weight	t	30	35	40	38	43	47	52
Machine size(L×W×H)	cm	945×420×550	945×475×550	1185×475×550	975×515×550	1215×515×550	1480×515×550	1620×515×550

## Standard Configuration

1. Controller:FANUC 0i
2. HISION built-in spindle
3. Spindle oil chiller
4. Pneumatic,hydraulic and lubrication system
5. Simple splash guard
6. Internal helix chip conveyor
7. External chain type chip conveyor
8. Cutting cooling
9. 3-color signal lamp, working light
10. Standard accessories
11. Common maintenance tools

## Option Configuration

1. Controller:FANUC 31i
2. Controller:SIEMENS 828D (only for Purchased built-in spindle)
3. Germany kessler(HSK-A63) 18000rpm/24000RPM built-in spindle
4. HISION(BT40) 12000rpm built-in spindle
5. 24T armless ATC
6. Column heighten
7. Coolant through spindle (2-6MPa)
8. Linear scale
9. CNC rotary table(4th)
10. Full enclosure
11. Auto milling head (only for 8000rpm built-in spindle)
12. 2 stations auto heads storing shelf (only for 8000rpm built-in spindle)
13. Workpiece probe
14. Tool setter
15. Oil skimmer
16. Workpiece air gun
17. Workpiece water gun
18. Air conditioner
19. Z axis travel 1000mm



# GLU

Items	Unit	GLU18×30	GLU23×30	GLU23×40
<b>» Machining Capacity</b>				
X travel	mm	3200	3200	4200
Y travel	mm	1700	2200	2200
Z travel	mm	1000	1000	1000
Distance between columns	mm	1800	2290	2290
Spindle nose to table surface	mm	250-1250	250-1250	250-1250
<b>» Table</b>				
Table size	mm	1500×3000	2000×3000	2000×4000
Table load	t	10	15	18
T slot	mm	22×160×9	22×200×9	22×200×9
<b>» Feed Rate</b>				
Cutting feedrate (X/Y/Z)	m/min	10/10/10	10/10/10	10/10/10
Rapid traverse (X/Y/Z)	m/min	15/20/15	15/20/15	12/20/15
<b>» Spindle</b>				
Max Spindle speed	rpm	6000	6000	6000
Spindle power	kW	15/18.5	22/26	22/26
Spindle torque	N.m	490/605	726/858	726/858
Spindle taper		BT50	BT50	BT50
Ram section	mm	350×350 (380x380 option)	350×350 (380x380 option)	350×350 (380x380 option)
<b>» Tool Magazine (Option)</b>				
Tool magazine capacity	T	24	24	24
Tool magazine type		BT50	BT50	BT50
Max.tool dia. (Adjacent vacant)	mm	Φ110 (Φ220)	Φ110 (Φ220)	Φ110 (Φ220)
Max.tool length	mm	300	300	300
Max.tool weight	kg	20	20	20
<b>» Other</b>				
Power capacity	kVA	40	55	55
Machine weight	t	30	35	40
Machine size(L×W×H)	cm	945×420×510	945×475×510	1185×475×510

## Standard Configuration

1. Controller:FANUC 0i
2. Gear box drive
3. Long nose spindle
4. Z axis hydraulic balancing system
5. Spindle oil chiller
6. Pneumatic,hydraulic and lubrication system
7. Simple splash guard
8. Internal helix chip conveyor
9. External chain type chip conveyor
10. Cutting cooling
11. 3-color signal lamp, working light
12. Standard accessories
13. Common maintenance tools

## Option Configuration

1. Controller:FANUC 31i
2. Controller:SIEMENS 828D/840Dsl
3. 24/40T ATC
4. 40T vertical & horizontal ATC
5. Column heighten
6. Crossrail (Y axis)extended 380 Square ram
7. (z axis travel 1000mm)
8. Coolant through spindle (2-6MPa)
9. Linear scale
10. CNC rotary table(4th)
11. Full enclosure
12. Auto milling heads
13. Manual milling heads
14. 2 stations auto heads storing shelf
15. Workpiece probe
16. Tool setter
17. Oil skimmer
18. Air gun
19. Water gun
20. Air conditioner

# GLU

Items	Unit	GLU28×30	GLU28×40	GLU28×50	GLU28×60
<b>» Machining Capacity</b>					
X travel	mm	3200	4200	5500	6500
Y travel	mm	2700	2700	2700	2700
Z travel	mm	1000	1000	1000	1000
Distance between columns	mm	2790	2790	2790	2790
Spindle nose to table surface	mm	250-1250	250-1250	250-1250	250-1250
<b>» Table</b>					
Table size	mm	2000x3000	2000×4000	2000×5000	2000×6000
Table load	t	15	18	22	25
T slot	mm	22 x 200 x 9	22×200×9	22×200×9	22×200×9
<b>» Feed Rate</b>					
Cutting feedrate (X/Y/Z)	m/min	10/10/10	10/10/10	10/10/10	10/10/10
Rapid traverse (X/Y/Z)	m/min	12/20/15	12/20/15	10/20/15	10/20/15
<b>» Spindle</b>					
Max Spindle speed	rpm	6000	6000	6000	6000
Spindle power	kW	22/26	22/26	22/26	22/26
Spindle torque	N.m	726/858	726/858	726/858	726/858
Spindle taper		BT50	BT50	BT50	BT50
Ram section	mm	350×350 (380x380 option)	350×350 (380x380 option)	350×350 (380x380 option)	350×350 (380x380 option)
<b>» Tool Magazine (Option)</b>					
Tool magazine capacity	T	24	24	24	24
Tool magazine type		BT50	BT50	BT50	BT50
Max.tool dia. (Adjacent vacant)	mm	Φ110 (Φ220)	Φ110 (Φ220)	Φ110 (Φ220)	Φ110 (Φ220)
Max.tool length	mm	300	300	300	300
Max.tool weight	kg	20	20	20	20
<b>» Other</b>					
Power capacity	kVA	55	55	55	55
Machine weight	t	38	43	47	52
Machine size(L×W×H)	cm	975 x 515 x 510	1215×515×510	1480×515×510	1620×515×510

## Standard Configuration

1. Controller:FANUC 0i
2. Gear box drive
3. Long nose spindle
4. Z axis hydraulic balancing system
5. Spindle oil chiller
6. Pneumatic,hydraulic and lubrication system
7. Simple splash guard
8. Internal helix chip conveyor
9. External chain type chip conveyor
10. Cutting cooling
11. 3-color signal lamp, working light
12. Standard accessories
13. Common maintenance tools

## Option Configuration

1. Controller:FANUC 31i
2. Controller:SIEMENS 828D/840Dsl
3. 24/40T ATC
4. 40T vertical & horizontal ATC
5. Column heighten
6. Crossrail (Y axis)extended 380 Square ram
7. (z axis travel 1000mm)
8. Coolant through spindle (2-6MPa)
9. Linear scale
10. CNC rotary table(4th)
11. Full enclosure
12. Auto milling heads
13. Manual milling heads
14. 2 stations auto heads storing shelf
15. Workpiece probe
16. Tool setter
17. Oil skimmer
18. Air gun
19. Water gun
20. Air conditioner



# GRU II

Items	Unit	GRU28 II ×30	GRU28 II ×40	GRU28 II ×50	GRU28 II ×60	GRU32 II ×40
<b>» Machining Capacity</b>						
X travel	mm	3200	4200	5500	6500	4200
Y travel	mm	2700	2700	2700	2700	3200
Z travel	mm	1000 (1250 option)	1000 (1250 option)	1000 (1250 option)	1000 (1250 option)	1000 (1250 option)
Distance between columns	mm	2800	2800	2800	2800	3200
Spindle nose to table surface	mm	150-1150	150-1150	150-1150	150-1150	250-1250
<b>» Table</b>						
Table size	mm	2000×3000	2000×4000	2000×5000	2000×6000	2500×4000
Table load	t	15	18	22	25	20
T slot	mm	22×200×9	22×200×9	22×200×9	22×200×9	28×200×12
<b>» Feed Rate</b>						
Cutting feedrate (X/Y/Z)	m/min	6/6/6	6/6/6	6/6/6	6/6/6	6/6/6
Rapid traverse (X/Y/Z)	m/min	15/15/10	12/15/10	10/15/10	10/15/10	12/15/10
<b>» Spindle</b>						
Max Spindle speed	rpm	4000	4000	4000	4000	4000
Spindle power	kW	22/26	22/26	22/26	22/26	22/26
Spindle torque	N.m	866/1023	866/1023	866/1023	866/1023	866/1023
Spindle taper		BT50	BT50	BT50	BT50	BT50
Ram section	mm	400×400	400×400	400×400	400×400	400×400
<b>» Tool Magazine (Option)</b>						
Tool magazine capacity	T	24/40	24/40	24/40	24/40	24/40
Tool magazine type		BT50	BT50	BT50	BT50	BT50
Max.tool dia. (Adjacent vacant)	mm	Φ110 (Φ220)	Φ110 (Φ220)	Φ110 (Φ220)	Φ110 (Φ220)	Φ110 (Φ220)
Max.tool length	mm	300	300	300	300	300
Max.tool weight	kg	20	20	20	20	20
<b>» Other</b>						
Power capacity	kVA	55	55	55	55	55
Machine weight	t	42	48	53	59	57
Machine size(L×W×H)	cm	1050×530×550	1250×530×550	1500×530×550	1700×530×550	1250×580×570

## Standard Configuration

1. Controller:FANUC 0i
2. Gear box drive
3. Z axis hydraulic balancing system
4. Spindle oil chiller
5. Pneumatic,hydraulic and lubrication system
6. Simple splash guard
7. Internal helix chip conveyor
8. Cutting cooling
9. External chain type chip conveyor
10. 3-color signal lamp, working light
11. Standard accessories
12. Common maintenance tools

## Option Configuration

1. Controller: FANUC 31i
2. Controller: SIEMENS 828D/840Dsl
3. 24/40T ATC
4. 40T vertical & horizontal ATC
5. Column heighten
6. Crossrail (Y axis)extended
7. Z axis travel 1250mm (ram 420x430&column heighten 200mm)
8. Coolant through spindle (2-6MPa)
9. Linear scale
10. CNC rotary table (4th)
11. Full enclosure
12. Auto milling heads
13. Manual milling heads
14. 2 stations auto heads storing shelf
15. Manual cart head stock
16. Workpiece probe
17. Tool setter
18. Oil skimmer
19. Water gun
20. Air gun
21. Air conditioner

# GRU II

Items	Unit	GRU32 II×50	GRU32 II×60	GRU32 II×80	GRU36 II×50	GRU36 II×60	GRU36 II×80
<b>» Machining Capacity</b>							
X travel	mm	5500	6500	8500	5500	6500	8500
Y travel	mm	3200	3200	3200	3600	3600	3600
Z travel	mm	1000 (1250 option)	1000 (1250 option)	1000 (1250 option)	1250	1250	1250
Distance between columns	mm	3200	3200	3200	3600	3600	3600
Spindle nose to table surface	mm	250-1250	250-1250	250-1250	200-1450	200-1450	200-1450
<b>» Table</b>							
Table size	mm	2500×5000	2500×6000	2500×8000	3000×5000	3000×6000	3000×8000
Table load	t	25	28	35	28	35	40
T slot	mm	28×200×12	28×200×12	28×200×12	36×200×14	36×200×14	36×200×14
<b>» Feed Rate</b>							
Cutting feedrate (X/Y/Z)	m/min	6/6/6	6/6/6	6/6/6	6/6/6	6/6/6	6/6/6
Rapid traverse (X/Y/Z)	m/min	10/15/10	10/15/10	10/15/10	10/15/10	10/15/10	10/15/10
<b>» Spindle</b>							
Max Spindle speed	rpm	4000	4000	4000	4000	4000	4000
Spindle power	kW	22/26	22/26	22/26	22/26	22/26	22/26
Spindle torque	N.m	866/1023	866/1023	866/1023	866/1023	866/1023	866/1023
Spindle taper		BT50	BT50	BT50	BT50	BT50	BT50
Ram section	mm	400×400	400×400	400×400	420×430	420×430	420×430
<b>» Tool Magazine (Option)</b>							
Tool magazine capacity	T	24/40	24/40	24/40	24/40	24/40	24/40
Tool magazine type		BT50	BT50	BT50	BT50	BT50	BT50
Max.tool dia. (Adjacent vacant)	mm	Φ110 (Φ220)	Φ110 (Φ220)	Φ110 (Φ220)	Φ110 (Φ220)	Φ110 (Φ220)	Φ110 (Φ220)
Max.tool length	mm	300	300	300	400	400	400
Max.tool weight	kg	20	20	20	25	25	25
<b>» Other</b>							
Power capacity	kVA	55	55	55	80	80	80
Machine weight	t	61	70	85	79	87	106
Machine size(L×W×H)	cm	1500×580×570	1700×580×570	2300×580×570	1500×620×695	1700×620×695	2300×620×695

## Standard Configuration

1. Controller:FANUC 0i
2. Gear box drive
3. Z axis hydraulic balancing system
4. Spindle oil chiller
5. Pneumatic,hydraulic and lubrication system
6. Simple splash guard
7. Internal helix chip conveyor
8. Cutting cooling
9. External chain type chip conveyor
10. 3-color signal lamp, working light
11. Standard accessories
12. Common maintenance tools

## Option Configuration

1. Controller: FANUC 31i
2. Controller: SIEMENS 828D/840Dsl
3. 24/40T ATC
4. 40T vertical & horizontal ATC
5. Column heighten
6. Crossrail (Y axis)extended
7. Z axis travel 1250mm (ram 420x430&column heighten 200mm)
8. Coolant through spindle (2-6MPa)
9. Linear scale
10. CNC rotary table (4th)
11. Full enclosure
12. Auto milling heads
13. Manual milling heads
14. 2 stations auto heads storing shelf
15. Manual cart head stock
16. Workpiece probe
17. Tool setter
18. Oil skimmer
19. Water gun
20. Air gun
21. Air conditioner





# GNU

Items	Unit	GNU28×30	GNU28×40	GNU28×50	GNU28×50	GNU32×40
<b>» Machining Capacity</b>						
X travel	mm	3200	4200	5500	6500	4200
Y travel	mm	2800	2800	2800	2800	3200
Z travel	mm	1250 (1500 option)	1250 (1500 option)	1250 (1500 option)	1250 (1500 option)	1250 (1500 option)
Distance between columns	mm	2800	2800	2800	2800	3200
Spindle nose to table surface	mm	150-1400	150-1400	150-1400	150-1400	250-1500
<b>» Table</b>						
Table size	mm	2000×3000	2000×4000	2000×5000	2000×6000	2500×4000
Table load	t	15	18	22	25	20
T slot	mm	22×200×9	22×200×9	22×200×9	22×200×9	28×200×12
<b>» Feed Rate</b>						
Cutting feedrate (X/Y/Z)	m/min	6/6/6	6/6/6	6/6/6	6/6/6	6/6/6
Rapid traverse (X/Y/Z)	m/min	15/15/10	12/15/10	10/15/10	10/15/10	12/15/10
<b>» Spindle</b>						
Max Spindle speed	rpm	3500	3500	3500	3500	3500
Spindle power	kW	30/37	30/37	30/37	30/37	30/37
Spindle torque	N.m	1860/2300	1860/2300	1860/2300	1860/2300	1860/2300
Spindle taper		BT50	BT50	BT50	BT50	BT50
Ram section	mm	450×450	450×450	450×450	450×450	450×450
<b>» Tool Magazine (Option)</b>						
Tool magazine capacity	T	24/40	24/40	24/40	24/40	24/40
Tool magazine type		BT50	BT50	BT50	BT50	BT50
Max.tool dia. (Adjacent vacant)	mm	Φ110 (Φ220)	Φ110 (Φ220)	Φ110 (Φ220)	Φ110 (Φ220)	Φ110 (Φ220)
Max.tool length	mm	400	400	400	400	400
Max.tool weight	kg	25	25	25	25	25
<b>» Other</b>						
Power capacity	kVA	65	65	65	65	65
Machine weight	t	49	54	63	70	64
Machine size(L×W×H)	cm	1050×530×675	1250×530×675	1500×530×675	1700×530×675	1250×570×695

## Standard Configuration

1. Controller:FANUC 0i
2. Gear box drive
3. Z axis hydraulic balancing system
4. Spindle oil chiller
5. Pneumatic,hydraulic and lubrication system
6. Simple splash guard
7. Internal helix chip conveyor
8. Cutting cooling
9. External chain type chip conveyor
10. 3-color signal lamp, working light
11. Standard accessories
12. Common maintenance tools

## Option Configuration

1. Controller:FANUC 31i
2. Controller:SIEMENS 828D/840Dsl
3. 24/40T ATC
4. 40T vertical & horizontal ATC
5. Column heighten
6. Crossrail (Y axis)extended
7. Z axis travel 1500mm(ram 500X500)
8. Coolant through spindle (2-6MPa)
9. Linear scale
10. CNC rotary table (4th)
11. Full enclosure
12. Auto milling heads
13. Manual milling heads
14. 2 stations auto heads storing shelf
15. Manual cart head stock
16. Workpiece probe
17. Tool setter
18. Oil skimmer
19. Water gun
20. Air gun
21. Air conditioner

# GNU

Items	Unit	GNU32×50	GNU32×60	GNU32×80	GNU36×50	GNU36×60	GNU36×80
<b>» Machining Capacity</b>							
X travel	mm	5500	6500	8500	5500	6500	8500
Y travel	mm	3200	3200	3200	3600	3600	3600
Z travel	mm	1250 (1500 option)	1250 (1500 option)	1250 (1500 option)	1250 (1500 option)	1250 (1500 option)	1250 (1500 option)
Distance between columns	mm	3200	3200	3200	3600	3600	3600
Spindle nose to table surface	mm	250-1500	250-1500	250-1500	200-1450	200-1450	200-1450
<b>» Table</b>							
Table size	mm	2500×5000	2500×6000	2500×8000	3000×5000	3000×6000	3000×8000
Table load	t	25	28	35	28	35	40
T slot	mm	28×200×12	28×200×12	28×200×12	36×200×14	36×200×14	36×200×14
<b>» Feed Rate</b>							
Cutting feedrate (X/Y/Z)	m/min	6/6/6	6/6/6	6/6/6	6/6/6	6/6/6	6/6/6
Rapid traverse (X/Y/Z)	m/min	10/15/10	10/15/10	10/15/10	10/15/10	10/15/10	10/15/10
<b>» Spindle</b>							
Max Spindle speed	rpm	3500	3500	3500	3500	3500	3500
Spindle power	kW	30/37	30/37	30/37	30/37	30/37	30/37
Spindle torque	N.m	1860/2300	1860/2300	1860/2300	1860/2300	1860/2300	1860/2300
Spindle taper		BT50	BT50	BT50	BT50	BT50	BT50
Ram section	mm	450×450	450×450	450×450	450×450	450×450	450×450
<b>» Tool Magazine (Option)</b>							
Tool magazine capacity	T	24/40	24/40	24/40	24/40	24/40	24/40
Tool magazine type		BT50	BT50	BT50	BT50	BT50	BT50
Max.tool dia. (Adjacent vacant)	mm	Φ110 (Φ220)	Φ110 (Φ220)	Φ110 (Φ220)	Φ110 (Φ220)	Φ110 (Φ220)	Φ110 (Φ220)
Max.tool length	mm	400	400	400	400	400	400
Max.tool weight	kg	25	25	25	25	25	25
<b>» Other</b>							
Power capacity	kVA	65	65	65	80	80	80
Machine weight	t	72	80	99	79	87	106
Machine size(L×W×H)	cm	1500×570×695	1700×570×695	2300×570×695	1500×620×695	1700×620×695	2300×620×695

## Standard Configuration

1. Controller:FANUC 0i
2. Gear box drive
3. Z axis hydraulic balancing system
4. Spindle oil chiller
5. Pneumatic,hydraulic and lubrication system
6. Simple splash guard
7. Internal helix chip conveyor
8. Cutting cooling
9. External chain type chip conveyor
10. 3-color signal lamp, working light
11. Standard accessories
12. Common maintenance tools

## Option Configuration

1. Controller: FANUC 31i
2. Controller: SIEMENS828D/840Dsl
3. 24/40T ATC
4. 40T vertical & horizontal ATC
5. Column heighten
6. Crossrail (Y axis)extended
7. Z axis travel 1500mm(ram 500X500)
8. Coolant through spindle (2-6MPa)
9. Linear scale
10. CNC rotary table (4th)
11. Full enclosure
12. Auto milling heads
13. Manual milling heads
14. 2 stations auto heads storing shelf
15. Manual cart head stock
16. Workpiece probe
17. Tool setter
18. Oil skimmer
19. Water gun
20. Air gun
21. Air conditioner



## MORE THAN PRECISION

Ningbo Haitian Precision Machinery Co., Ltd. is a listed company specializing in machine tooling industry. It has developed Ningbo Dagang production base, Ningbo Yanshan production base and Dalian production base. It has a modern constant temperature processing and assembly plant of over 300,000 square meters with nearly 1500 employees. It is awarded honors such as "national major technical equipment enterprise", "national high-tech enterprise", and "provincial high-tech research and development center".

